

Step by step guide
for
**100% Solarization of
Academic Campuses**

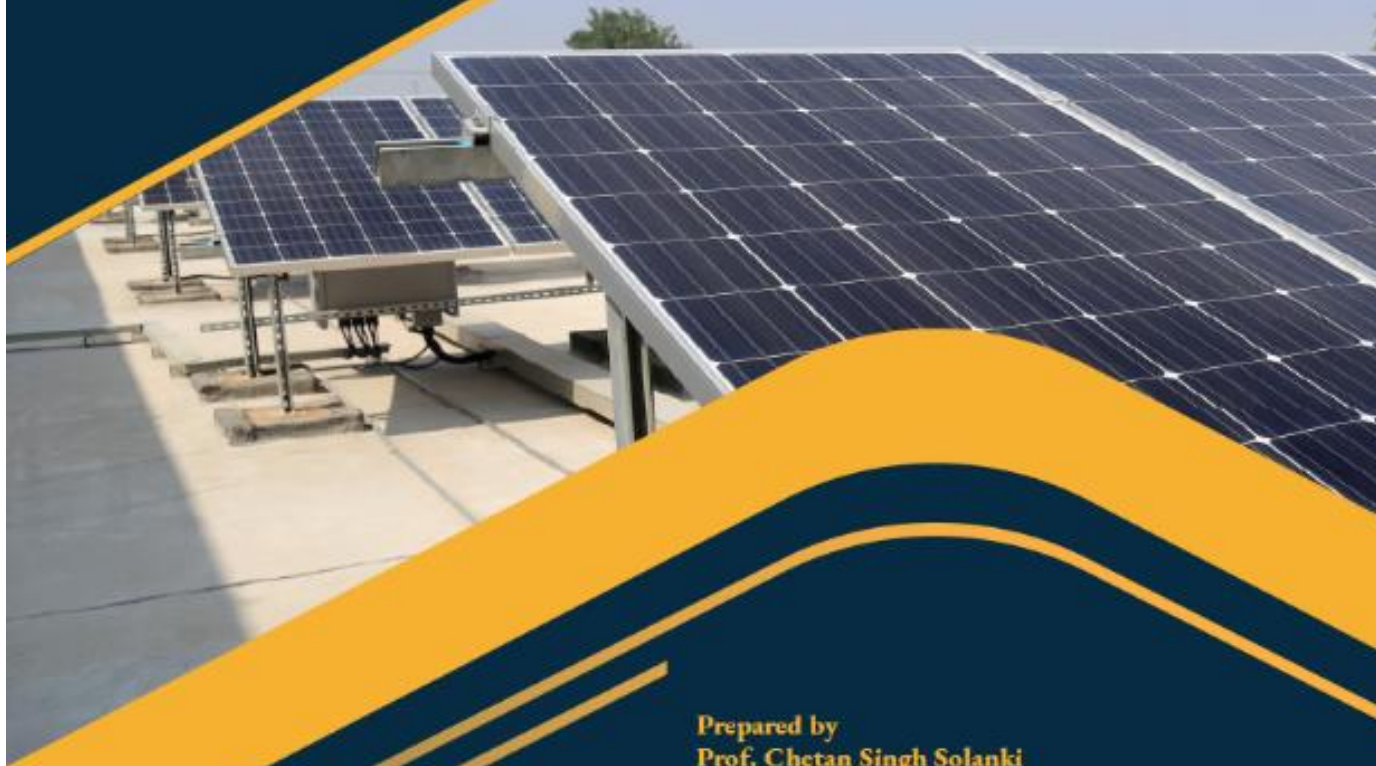

Prepared by
Prof. Chetan Singh Solanki
Brand Ambassador of Solar Energy of
Government of Madhya Pradesh &
Professor, IIT Bombay &
Founder, Energy Swaraj Foundationy



AVOID



MINIMIZE



GENERATE



Directorate Technical Education
Government of Madhya Pradesh



तकनीकी शिक्षा संचालनालय
मध्यप्रदेश शासन

Sometimes...

*In our limited vision, we miss out the bigger picture,
In our ability to understand only finite, we forget the infinite,
In our limited wisdom, we tend to make mistakes much
harmful than we think,
In our limited capacity to comprehend, we cannot understand
the vastness of the universe,
In our one-dimensional focus on wealth creation, we forget the
multi-dimensionality of life,
In our desire to make life comfortable, we forget the
discomfort that we cause to others,
In our short life span, we forget the timelessness of the Earth.*

- *Chetan Singh Solanki*



*There is no Planet B
Let us save Planet A*

Preface

Today, the world faces an Energy Paradox, wherein more energy is required to ensure fast-paced economic growth, while rampant use of energy is causing catastrophic climate change. Younger generation are going to bear the burden of it, more than anyone else. The solution to climate change lies in stopping the use of fossil energy drastically and immediately and switching to 100% solar energy. Academic campuses are responsible for building the future of the young generation. Academic campuses can start to become self-sufficient in energy and start a revolution towards Atmanirbharta in energy. This document gives step by step approach on how academic campuses can move towards 100% solar powered campus. It talks about Avoid, Minimize and Generate approach to bring down energy requirement significantly and then provides design thumb rule to estimate the size of solar system components. The report also helps in clarifying doubts on usage of solar energy. At the end, this report talk about an approach to implement 100% solar solutions by involving faculty members and students of the institute in two years' time frame.

Contents

1. Energy and Climate change	1
2. Academic campuses: Shaping the future of the future	4
3. Two guiding principles of sustainability	5
4. Atmanirbhar Madhya Pradesh and Bharat	7
5. 100% possibility of 100% solarization	8
- Academic institution's operations mostly synchronized with daylight	8
- Solar PV systems with battery back up	9
- The economic viability of solar PV systems (solar electricity numbers)	10
- Design for the rainy season	10
- Sufficiency of rooftop area for academic campuses	11
- Repair and maintenance of solar systems	12
6. Typical loads of academic campuses	12
7. Avoid-Minimize-Generate 3 step approach for 100% solarization	13
a. Step-1: Avoid by 1/3 rd	13
b. Step-2: Minimize by 1/3 rd	15
c. Step-3: Generate remaining 1/3 rd	23
8. Thumb rule for solar system design and costing	23
9. Step by step implementation towards 100% solar by locals for locals	26
Team building – students and faculty	27
Energy Auditing	27
Applying Avoid Formula	27
Applying Avoid Formula	28
Design and costing solar systems	28
Procurement of solar system	29
Installation of solar systems	29
Documentation and Promotion	29
10. Timeline for implementation	30
Annexure-1 - Estimation of electricity needs within an academic institution	31
Annexure-2: Approach for designing solar off-grid systems	35

Step by Step guide

for

100% Solarization of

Academic Campuses

1. Energy and Climate change

Energy is the capacity of a body to do work. A body that possesses energy can perform a work. By using sources of energy we get the work done through machines. By using petrol in our vehicle we move ourselves from one place to another. By using LPG in our cookstoves, we get the food cooked. Blow of wind can help us in drying our clothes. Burning of coal can propel an engine. Due to heating caused by Sunlight, the water evaporates from the surface. In this way, Petrol, LPG, Wind, Coal, Sunlight possess energy.

The world is a play of energy – It is an amalgamation of positive and negative energy, creative and destructive energy, righteous and unjustifiable energy, dark and bright energy, coal energy and solar energy!

In this modern world, energy is the main driver of social and economic growth. Today, every moment of our life and every square inch of space that we utilise has a touch of energy. It is really unthinkable to live a single day without consuming any form of energy. For individuals, higher use of energy not only enables better comfort but also higher income and better health. For an industry, higher energy consumption means more production of goods and services. And, for a country, higher energy

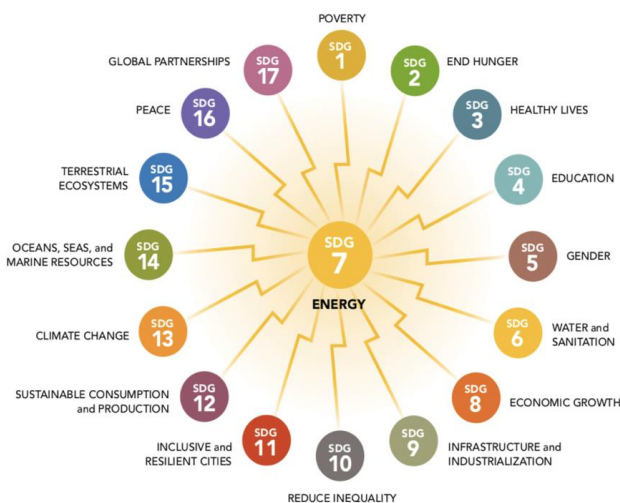

Figure 1: Energy at the core of achieving SDGs (Ref: UN)

consumption means higher human development index, a larger production and higher GDP. In fact, Sustainable Development Goal 7 – Affordable Energy for all, is the centre for achieving almost all other goals, as shown in figure.

Humans have existed on this planet for several thousands of years. Therefore, it is only obvious that the energy source that humans consume should have also existed since long and should have potential to exist for millions of years, for hopefully so

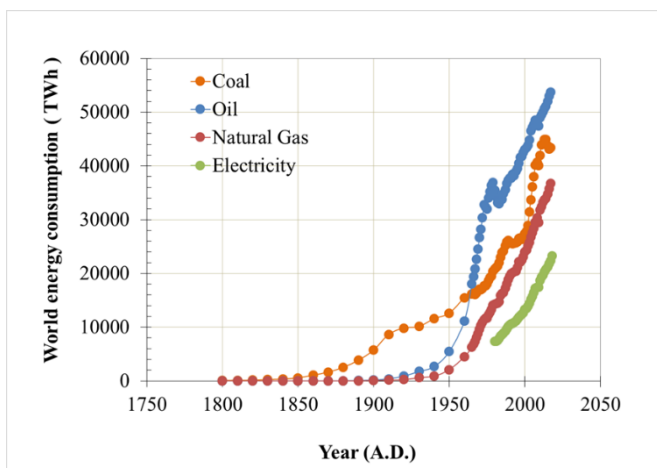

Figure 2: World Energy Consumption from various sources

much longer human existence on this planet. However, today, most of the human activities, around the world, is running on finite energy resources – the fossil fuels i.e. coal, oil and gas which are incessantly emitting carbon dioxide. And carbon dioxide is causing enormous pollution on planet earth. Not only this, it is creating a huge imbalance in nature, which is leading to climate change and making the sustainability of

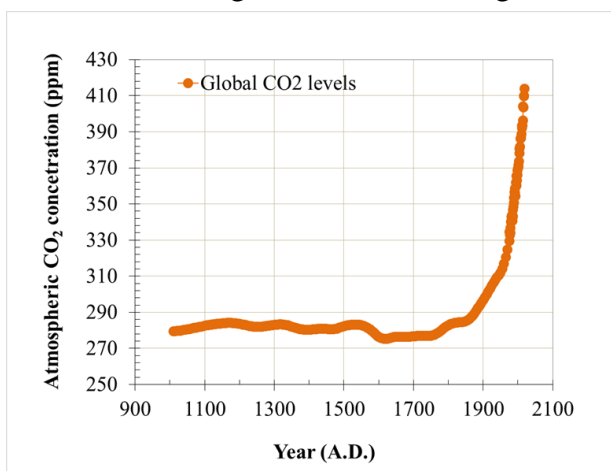

Figure 3: Global atmospheric carbon concentration

of human beings on this planet questionable.

Till, as late as 1850, we see that the life on the planet with regard to energy generation and consumption was in complete sync with nature. Gradually, the scenario started changing, the dark energies of coal and crude

oil made their way and soon gained momentum. Since the onset of the industrial revolution (Since 1850), we discovered the use of coal and oil, the balance of energy consumption and generation on the planet started getting disturbed. Since then, we have been digging out the carbon stored beneath the Earth's surface for millions of years and started burning these fuels, which started emitting carbon in the form of carbon dioxide in the atmosphere. Prior to 1850, the exchange of carbon dioxide between the Earth and atmosphere that is emission to the atmosphere and absorption from the atmosphere, was in perfect balance, therefore the existence of life was in balance.

Climate change and energy use are just the two faces of the same coin. It can be better understood from the trends of total primary energy consumption of the world and CO₂ emissions.

The graph on the left panel shows the concentration of carbon emissions in the atmosphere since the past century. As the dependency on coal and associated carbon-based fuels have increased steadily to fulfil our energy needs, the atmospheric carbon concentration has also increased considerably. This has led to global warming. As per the Intergovernmental Panel on Climate Change (IPCC) special report, the world is already **hotter by 1°C**.

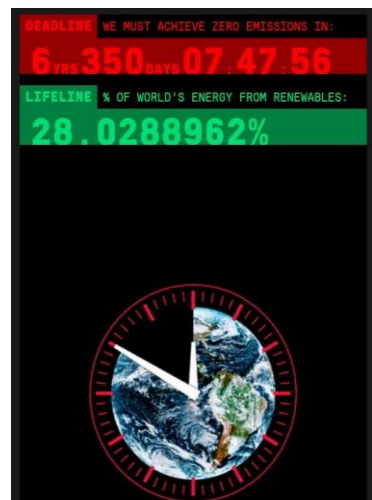

Figure 4: Years left for utilizing the Carbon budget

Today, the world faces an Energy Paradox, wherein more energy is required to ensure fast-paced economic growth, while rampant use of energy is causing catastrophic climate change. More than 80% of our energy needs are being fulfilled through fossil fuels. The byproduct of use of carbon fuel is CO₂, which is a greenhouse gas, responsible for climate change. Climate change is turning out to be a major crisis of the world, and even becoming an existential threat to humanity. Dalai Lama recently said that *"More and more people understand that the survival of humanity is at*

stake. Simply meditating or praying for change is not enough. There has to be action". We need to take action.

The climate crisis has become more prominent in recent years. The world has become warmer by 1 degree Celsius, which is causing many erratic events on the planet. Snowfall in the deserts of Dubai, wild bushfires in Australia, heatwaves in Europe, large scale melting of glaciers, droughts, and floods in many parts of the world are examples of climate crisis of recent times. As per the Intergovernmental Panel on Climate Change (IPCC) special report, the world is already hotter by 1°C. It is imperative to limit global warming to ideally 1.5 °C or at max to 2°C to avoid irreversible change in the climate. As per the current rate of global CO₂ emission, there are only about 7 to 8 years left before the global temperature rises to 1.5 degree Celcius on an average. Time is really slipping out of our hand. We need rapid and far-reaching transitions in energy use. We need to take action.

2. Academic campuses: Shaping the future of the future

Madhya Pradesh is one of the top 8 states in terms of highest number of Colleges in India are having 28 and more Colleges per lakh population. In Madhya Pradesh, over 13 lakh students were enrolled in the colleges in the year 2017-18, as per the All India Survey on Higher Education Report published by Ministry of Human Resources and Development.¹ It is important to sensitize and make aware the young generation about this delicate correlation between the Energy and Climate as it is them who are going to live longer on this planet, it is them who are going to suffer the catastrophe of climate change. It is duty of the world to prepare the young generation in understanding the impact and training them to take part in mitigation of climate change.

¹ <https://epsiindia.org/wp-content/uploads/2019/02/AISHE-2017-18.pdf>

Young generations must take a proactive approach in mitigating climate change, as concurred by any world leaders. Youth are adaptable and can quickly make low-carbon lifestyles. Youth can be the key actors in raising awareness, running educational programs, promoting sustainable lifestyles, conserving nature, supporting renewable energy, adopting environmentally-friendly practices and implementing adaptation and mitigation projects. They can be the voice of Mother Nature, which has been destroyed rampantly by the past and the present generations. Instead of being the passive spectators of the destruction caused by climate change and perhaps to their future, the young generation has now begun to fight back at a scale never seen before. Therefore, they can be the key to sustainable development. Youth can be prioritized as the sustainable development innovators as per the recent UNCTAD report.

Academic Institutions play a key role in shaping the future of the young generation. They are example setters for the young generation and a knowledge hub. If academic institutions follow sustainable development practices and run their campuses 100% on solar, the youth may also be encouraged to follow the same. Furthermore, to make the young generation a key part of the long and sustainable future on the planet, their total development is required, developing body, mind, soul, and intelligence.

In this context, Mahatma Gandhi coined the concept of training of '3 H', the Head, Heart, and the Hand. Teaching to students about the relationship between energy and climate change (training head), teaching them to care for mother nature (training heart) and involving them in design, installation and maintenance of 100% solar powered campus (training hand) would be an wonderful example not only for state of Madhya Pradesh, but also for India and for the whole world.

3. Two guiding principles of sustainability

Before one think of designing 100% solar powered campuses, it is mandatory to do it in a manner that it is sustainable and has little or no

negative impact on the environment. Solar PV technology has low carbon footprint but not zero, therefore the use of the technology, even if it is solar has to be done carefully.

Two ideologies of Mahatma Gandhi could be our guiding principles. He said, “there is only enough in the world for everyone’s need but not anyone’s greed”, and “not the mass production but production by masses is required”. These can be written down in two fundamental laws of sustainability of human life on the planet.



1st Law of Fundamental of Sustainability - "In an ecosystem of finite resources, there has to be finite consumption."

On the planet Earth, everything is finite. There is only finite land, water, forest, fossil fuels, and the environment, hence our consumption should also be finite. But growing economies are based on more and more consumption. Due to the absolute violation of this 1st Fundamental Law, the world is facing a climate crisis today. There is a need to reduce and limit our consumption in line with this fundamental law, not increase it. More consumption results in a higher circulation of money, but it also results in many other problems, including the grave issue of climate change.



2nd Law of Fundamental of Sustainability - "In an ecosystem of finite resources, there has to be distributed production."

The mass production results in unequal distribution of resources and benefit in community. Higher difference would also lead to higher dissatisfaction and even violence. In such a finite resources scenario, only the production-by-masses can provide equal opportunities to all to earn their living. Only an equal and balanced world could be prosperous

and peaceful. Such an arrangement will also result in minimal or no strain on the environment while fulfilling our daily needs.

These two fundamental laws of sustainability can provide us a guide in approach towards a 100% solar powered campus. The first law tells us to limit our electricity consumption in academic campuses, and the second law tells us to generate electricity locally with involvement of the local community.

4. Atmanirbhar Madhya Pradesh and Bharat



“Atmanirbhar Bharat is not about being self-contained or being closed to the world, it is about being self-sustaining and self-generating.”

Honorable Prime Minister Shri Narendra Modi, while addressing the nation on the CoViD-19 situation, had proclaimed, "When the world is in crisis, we must strengthen our resolve. Our great resolve will help overcome this crisis. The state of the world today teaches us that a "Self-reliant India" is the only path." Huge supply chain disruptions and distorted international markets prompted the Prime Minister to voice "#VocalforLocal" and an "Atamnirbhar Bharat." Prime Minister has set a vision on the self-reliant India

and empowering the local communities of India

With a strong commitment towards the Prime Minister's vision of Atamnirbhar Bharat, the Honorable Chief Minister of Madhya Pradesh, Shri. Shivraj Singh Chouhan launched the Atmanirbhar Madhya Pradesh Roadmap 2023, with the vision of becoming self-reliant Madhya Pradesh by 2023, thereby contributing to the making of Atmanirbhar Bharat. “Prime Minister Modi is our inspiration. He had appealed to all states to support the Atmanirbhar Bharat mission, and urged to turn the Corona challenge into an opportunity. Atmanirbhar MP is essential for building

Atmanirbhar Bharat”, Chief Minister had said during the launch of the Atmanirbhar Madhya Pradesh Roadmap 2023.

Making academic campuses Atmanirbhar in energy, where they produce and consume their own energy needs, is in line with Atamanirbhar Atamnirbhar Bharat. Atmanirbhar Madhya Pradesh is in line with Atmanirbhar Bharat. In this context, shifting the academic institutions on 100 % solar power is making institutions Atmanirbhar, which is in line with Atmanirbhar Madhya Pradesh. Making campuses Atmanirbar in Madhya Pradesh is not only visionary step by Govt. of Madhya Pradesh but it would also be an leading example for the world. These efforts would be laudable as it contributes to many sustainable development goal of United Nations.

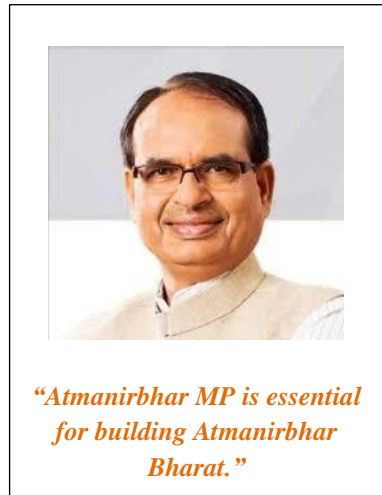

5. 100% possibility of 100% solarization

With the current advancement in solar technology and its cost reduction, availability of modules and access to training enables 100% solarization of academic campuses. There are several other compelling reasons that gives confidence in 100% solar powered academic campuses. This section also clarifies doubt that users may have about solar electricity solutions.

- **Academic institution's operations mostly synchronized with daylight**

Typically academic institutions run during the daytime. The operation starts from the morning, 8.00 – 09.00 A.M. and can go up to the evening, 4.00 – 5.00 P.M. These timings are well synchronized with the availability of sunlight. As a result, generation and consumption are well

synchronized, and the need for energy storage would reduce significantly, reducing the overall cost and maintenance needs.

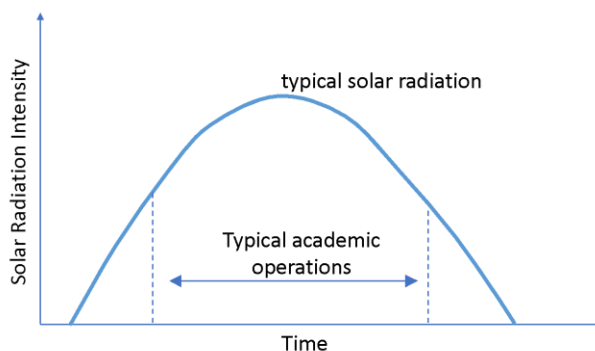

Figure 5: Sunshine hours are synchronized with typical operation hours of academic institutions

- Solar PV systems with battery back up

A completely Atmanirbhar academic campuses can show the example and pave the way for an Atmanirbhar Madhya Pradesh and Atmanirbhar Bharat. An Atmanirbhar campus means a campus without any electricity connection from the grid. Atmanirbhar campus is also proposed considering the (a) difficulty in connecting solar system with the electricity grid, (b) limit put by electricity board on maximum generation using solar, (c) need to pay for fixed charges for all loads even if it runs with solar, (d) need to pay for monthly electricity bills, & (e) overuse or misuse of electricity when supply is not a constraint, that is the case of grid connection. Therefore, based on the above consideration, a solar PV system with battery back-up is suggested. For running the loads smoothly during non-sunshine hours and rainy and cloudy days, battery back-up can be appropriately designed.

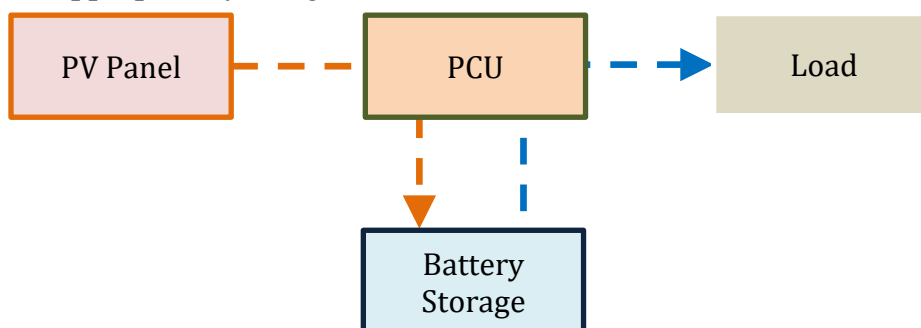

Figure 6: Solar PV system configuration with energy storage for non-sunshine hours

- **The economic viability of solar PV systems (solar electricity numbers)**

An Atmanirbhar campus not connected with the grid is an example of a fully solar-powered campus with partial battery back-up for night operations (unlike the homes full battery back-up where significant loads run during the night). Typically, a solar system is designed to run for the lifetime of solar panels, which is about 25 years. In solar PV systems, there is a high initial cost but a very low running cost. For such cases, an accurate estimation of electricity cost is given in terms of Levelized Cost of Electricity (LCOE). For grid-connected systems without battery back-up, LCOE comes to about 2.6 to 3.5 Rs per unit. For fully off-grid with full battery back-up, it is in the range of 7.5 to 10 Rs per unit depending on battery capacity.

The LCOE for off-grid solar systems with partially battery-backed academic institutions comes in the range of Rs. 5.5 to 7.0 per unit. This is less than or equal to the current cost of electricity that academic institutions are paying. In this way, becoming an Atmanirbhar campus is not only a great example of academic leadership and vision to the nation, but it is also an economically viable option.

- **Design for the rainy season**

Solar radiation data in kWh/m²/day for four major cities of Madhya Pradesh is given in the table below (Ref: NREL data, SAM). One can compare the solar radiation data for monsoon months with summer months. The solar radiation during the monsoon months is about 10 to 25% less than the summer months. This will reduce the generation in monsoon months by a similar order. During the monsoon months, the electricity requirements also decreases. Still, if we need to compensate for reduced radiation, one can add extra generation capacity (extra PV modules) in the same percentage to reduce radiation.

Table 1 Monthly solar radiation of major cities of MP (ref: NREL, SAM)

Months	Monthly Average Solar Radiation kWh/m ² /day			
	Gwalior	Bhopal	Jabalpur	Indore
Jan	4.04	4.58	4.61	4.66
Feb	4.96	5.58	5.58	5.72
Mar	6.13	6.52	6.43	6.62
Apr	6.87	6.95	6.99	7.00
May	6.84	7.00	6.93	7.09
Jun	6.24	5.77	5.72	6.01
Jul	5.18	4.71	4.74	4.54
Aug	5.24	4.46	4.49	4.33
Sep	5.54	5.45	5.31	5.34
Oct	5.10	5.52	5.55	5.39
Nov	4.19	4.68	4.75	4.73
Dec	3.62	4.40	4.37	4.44

- Sufficiency of rooftop area for academic campuses

Academic campuses are typically 2 or 3 or 4 storied buildings. A simple calculation shows that there is always sufficient rooftop space for meeting their full energy requirements. For instance, let's consider the average solar radiation of about 5.5 kWh/m²/day. This is very much common in the entire Madhya Pradesh. The efficiency of solar PV modules available in the market is normally 17 to 18%, and the efficiency of other solar PV system components is about 75 to 80%. In this way, from 1 m² of rooftop area taking conservative numbers, one can

generate $5.5 \times 17/100 \times 75/100 = 0.70$ kWh /m²/day of electricity. Assuming an institution has a rooftop area of 1000 meters (roughly 10,000 Square feet), it can generate about 700 units of electricity per day or about 21,000 electricity units per month. This should suffice the needs of almost every academic institution.

Typically, on average, a 10 square meter floor area of academic campus would consume at most 1 kWh of electricity per day. In this way, if the building has a 1000 square meter area, and it has three floors, it will at most consume about 1000 square meters x 1 kWh/10 square meter x 3 floor = 300 units of electricity per day or 9000 units of electricity per month. At the same time, the potential for electricity generation is about 21000 units per month. This demonstrates that there is always enough rooftop area available on academic campuses to fulfil its requirements.

- **Repair and maintenance of solar systems**

Anything that moves requires more maintenance. The solar PV module does not have any moving parts; therefore, there is no wear and tear. It requires only cleaning of the dust. The module cleaning once in 10 to 20 days should be good enough for maintenance depending on the dust level. PV module has a life of 25 years, but it can be used up to 40 years. In off-grid solar systems, batteries and electronics are other components. Battery and electronics require maintenance and replacement approximately once in 5 years. It is envisaged that faculty members and students will take part in the installation and maintenance of the entire solar system for the campus.

6. Typical loads of academic campuses

There are many types of loads in academic institutions such as lighting, fan, computers, projectors, water pump, water cooler, air conditioners, etc. When the solar PV system is designed to be off the grid, without any electricity connection, the question that comes to mind is whether the off-grid system can supply all kinds of loads or not? The answer is definitely

yes. Solar PV systems, if appropriately designed, can supply all types of loads, including air conditioning.

Academic campus loads can be summarized in three categories:

- Classroom loads
- Administrative loads
- Laboratory loads

The description in annexure-1 gives an idea of the amount of electricity required to run these loads on an academic campus.

7. Avoid-Minimize-Generate 3 step approach for 100% solarization

Earth is an ecosystem with finite resources; therefore, the consumption of resources can also be finite. Without limiting consumption, any amount of science and technology would not result in a sustainable future. With this philosophy, the academic campuses must reduce their electricity requirements as much as possible before they plan for the generation with solar.



Avoid (1/3rd)



Minimize (1/3rd)



Generate (1/3rd)

Avoid - Minimize - Generate (AMG) approach or 1/3rd-1/3rd-1/3rd approach is proposed for making academic campuses 100% solarized.

a. Step-1: Avoid by 1/3rd

Solar PV modules are considered a relatively much cleaner source of electricity than coal-based electricity, but they do have some non-zero

carbon footprint. Purification of Silicon, the production of silicon wafer, solar cells, glass, and aluminium frame all require energy. Energy consumption in production means the carbon footprint. After the end of life, solar PV modules and other system components like electronics and batteries would become waste. This waste would be required to recycle. Therefore, from a long-term perspective, it would be better to minimize the generation of any waste. Hence the first rule of using solar energy would be to "Avoid" electricity use even if produced using solar energy.

Avoid the use of energy refers to avoid using appliances that can be avoided. The solar team of students and faculty members of the campus can decide what can be avoided? The solar team should try to reduce electricity consumption by 1/3rd simply by avoiding the use of appliances. What can be avoided? Following are some examples:

- The use of lights and fans in the corridor can be avoided during day time
- In the rooms and halls, keeping the window curtains open can avoid the use of lights during day time
- Keeping the computer screen off and computer off when not in use avoids the use of electricity
- Using the switch rather than remote controls avoids the use of electricity
- Use of air conditioners can be avoided in most parts (instead of keeping the building cool with reflective paints on roof and walls, a plantation near building areas, plantation on rooftop areas
- Solar PV modules installed on the roof would reduce the heat gain. It can help in avoiding the use of AC
- Avoiding the use of electric water cooler with the natural water cooler,

...and there can be many more possibilities of avoiding the use of energy

With these measures and many more, the academic campuses keep targeting the avoid use of electricity by 1/3rd. The solar team of the institute can invite creative suggestions from other campus faculty and students. In this way, without spending any money, the electricity bill can be reduced by almost 1/3rd, which will be significant. This saving of money can be invested for the next step of a 100% solar-powered campus that minimizes electricity use.

b. Step-2: Minimize by 1/3rd

Minimizing electricity use refers to reducing the use of electricity for a given operation using efficient appliances. Thus in this step, we try to reduce electricity consumption by replacing less efficient appliances with more efficient appliances. For example, using an LED bulb or tube light reduces electricity consumption by almost 2.5 to 3 times compared to fluorescent lights. This requires the replacement of normal load with efficient loads. For every gadget that uses electricity, there are efficient alternatives available in the market. With efficient appliances, electricity consumption can be reduced by 20 to even 50 percent.

Electricity minimization for lighting

Use of efficient lighting devices can help us in reducing our electricity consumption. LEDs are more efficient devices than the fluorescent lights (tube light and CFL). Typical commercial CFL gives about 50-60 lumens per Watt while a commercial LED bulb will provide about 110-120 lumens per Watt. It means that for the same light output, we need only half the electricity when we use LEDs. A 10 Watt LED would give light output equivalent to a 20 Watt CFL. Similarly, when replacing ordinary tube lights with energy efficient LED tube light, we can save 50% of the electricity. A comparison of electricity saving potentials for use of LED bulb and LED tube lights instead of CFL and ordinary tube lights respectively are given in tables below.

Table 2: Energy savings from replacement of a CFL with LED bulb with similar lighting

Appliance	Old	New	% Energy Saving	Energy Saving (kWh)		
				Daily	Monthly	Yearly
Lighting	CFL	LED				
Power rating (W)	20	10				
Usage (h)	10	10				
Energy cons. (Wh)	200	100	50%	0.1	3	36.5

Table 3: Energy savings from replacement of a tube light with energy efficient LED tube light with similar lighting

Appliance	Old	New	% Energy Saving	Energy Saving (kWh)		
				Daily	Monthly	Yearly
Lighting	Tube light	LED Tube light				
Power rating (W)	40	20				
Usage (h)	10	10				
Energy cons. (Wh)	400	200	50%	0.2	6	73

Electricity minimization for fans

Use of efficient motor in motor based appliances can help us in saving electricity. The appliances which usually run on induction motor such as fans, water pump, compressor pumps, etc. are available in more efficient alternative where induction motor is replaced with DC motor. For example, the induction motor based Fan (table fan or ceiling fan) can now be replaced with the energy efficient BLDC (brushless DC) motor based fans having advanced speed control systems. Using energy efficient BLDC fans, we can reduce electricity consumption by at least 50% for a ceiling fan. Typically there are many fans in any academic campus, and replacing old fans with new efficient fan can significantly help in reduction of electricity consumption. A comparison of electricity saving potential for use of BLDC fans instead of a normal AC fan is given in table below.

Table 4: Energy savings from replacement of a normal ceiling fan with BLDC fan of similar output

Appliance	Old	New	% Energy Saving	Energy Saving (kWh)		
				Daily	Monthly	Yearly
Ceiling Fan	AC	BLDC				
Power rating (W)	75	30				
Usage (h)	8	8				
Energy cons. (Wh)	600	240	60%	0.36	11	131



75W AC Ceiling Fan



30W BLDC Ceiling Fan

Now a days, air coolers are also one of the popular appliances used in summer season as a low cost alternative of air conditioners. It works on the principle of evaporative cooling of water, mainly consisting of a fan and small water pump as energy consuming equipments. A comparison of electricity saving potential for use of using energy efficient air cooler instead of a normal air cooler is given in the table below.

Table 5: Energy savings from replacement of a normal air cooler with energy efficient air cooler of similar output

Appliance	Old	New	% Energy Saving	Energy Saving (kWh)		
				Daily	Monthly	Yearly
Air cooler	Normal	Energy Efficient				
Power rating (W)	300	170				
Usage (h)	8	8				
Energy cons. (Wh)	2400	1360	43%	1.0	30	150
*Note: Assuming avg. 10 hours of operation for 5 months in a year						

Electricity minimization for computers and projectors

Computers and projectors are very important electrical appliance today, particularly in the educational institutes with significant electricity input. Thus, lot energy savings can be made if we select the right energy efficient appliances. For example, low power consuming computer systems and energy efficient LED projectors are available in the market. A comparison of electricity saving potentials for use of energy efficient computer systems and LED projectors are given below:

Table 6: Energy savings from replacement of an ordinary projector system with energy efficient projector system of similar output specs

Appliance	Old	New	% Energy Saving	Energy Saving (kWh)		
				Daily	Monthly	Yearly
Projector System	Normal	Energy Efficient				
Power rating (W)	500	200				
Usage (h)	4	4				
Energy cons. (Wh)	2000	800	60%	1.2	36	438

Table 7: Energy savings from replacement of an ordinary computer system with an energy efficient computer system of similar output specs

Appliance	Old	New	% Energy Saving	Energy Saving (kWh)		
				Daily	Monthly	Yearly
Computer System	Normal	Energy Efficient				
Power rating (W)	150	70				
Usage (h)	8	8				
Energy cons. (Wh)	1200	560	53%	0.6	19.2	234

Electricity minimization for other appliances

There are other appliances that work based on motor and compressors; like water pump, refrigerators and air conditioners. The use of efficient motor in the appliance can give us electricity saving. In case of water pumps, we can now use submersible DC pumps instead using induction motor based water pumps, saving at least 25% of the total energy consumption.

Similarly in case of refrigerators and air conditioners, we can prefer to use the appliances with higher star ratings, defined by the BEE (Bureau of Energy Efficiency), Govt. of India. For example: the energy saving of a 5-star rated 190L refrigerator is 59% compared to 1-star rated appliance. Similarly, a 1.5-ton 5 star rated air conditioner saves about 23% of the electricity compared to 1-star rated appliance. The new inverter AC technology help to reduce electricity consumption of about 30 to 35% compared to normal AC. Now a days, advanced energy efficient DC compressor pumps are also available, thus we can have the energy efficient refrigerators or air conditioners in our homes that directly run on DC power (i.e. solar) and save energy. A comparison of electricity saving potential for use of 5-star refrigerator instead of 1-star is given in table below.

Table 8: Energy savings from use of energy efficient refrigerator of similar capacity
 Ref. Bureau of Energy Efficiency (<https://www.beestarlabel.com>)

Appliance	Old	New	% Energy Saving	Energy Saving (kWh)		
				Daily	Monthly	Yearly
Refrigerator (190L)	1-star	5-star				
Power rating (W)	--	--				
Usage (h)	24	24				
Energy cons. (kWh/year)	379	155	59%	--	--	224

A comparison of electricity saving potential for use of 5-star AC instead of 1-star AC is given in table below:

Table 9: Energy savings from use of energy efficient air conditioner of similar capacity

Appliance	Old	New	% Energy Saving	Energy Saving (kWh)		
				Daily	Monthly	Yearly
Air conditioner (1.5-ton)	1-star	5-star				
Power rating (W)	1926	1486				
Usage (h)	8	8				
Energy cons. (Wh)	15.4	11.9	23%	3.5	105	525*
*Note: Assuming 8 hours of operation for 5 months in a year						

A comparison of electricity saving potential for use of BLDC submersible pump instead of AC surface water pump is given in table below.

2 hp AC Water Pump



2 hp BLDC Submersible Water Pump

Table 10: Energy savings from replacement of a surface water pump with energy efficient submersible DC pump of similar rating

Appliance	Old	New	% Energy Saving	Energy Saving (kWh)		
				Daily	Monthly	Yearly
Water Pump (2 hp)	AC	BLD C				
Power rating (W)	1500	1400				
Usage (h)	0.25	0.20				
Energy cons. (Wh)	375	280	25%	0.1	3	35
Note: Efficient pump requires less energy to do same amount of work						

A comparison of electricity saving potential for use of LED Television instead of old CRT-based television is given in table below.

Table 11: Energy savings from replacement of an old CRT-television with energy efficient LED TV of similar size and type

Appliance	Old	New	% Energy Saving	Energy Saving (kWh)		
				Daily	Monthly	Yearly
Television	CRT	LED				
Power rating (W)	150	50				
Usage (h)	4	4				
Energy cons. (Wh)	600	200	67%	0.4	12	146

At present, LED televisions are very common, and you hardly find any CRT (cathode ray tube)-TV being used in cities. However, large number of population in the villages still using the old CRT-based TVs. The LED TVs are far more energy-efficient and consume 1/3rd of the power compared to old CRT-based televisions, thus saves 67% of the electricity. Therefore, LED TVs are preferred, but it is not recommended to discard any working CRT-TV and generate the E-waste.



150W 28 inch CRT color



50W 28 inch LED color

Thus, a significant energy saving can be achieved from just using energy efficient appliances. For example, about 1528 kWh (38%) of electricity can be saved annually considering a house with given nos. of appliances as shown in the table below.

Table 12: Energy Saving from using energy efficient appliances

Appliances	Daily Usage (Hour)	Normal Appliances		Equivalent Energy Efficient Appliances		% reduction in electricity
		Power Rating (Watt)	Total Energy Consume (Wh)	Power Rating (Watt)	Total Energy Consume (Wh)	
Bulb	10	20	200	10	100	50
Tubelight	10	40	400	20	200	50
Fan	8	75	600	30	240	60
Air Conditioner (1.5 ton)	8	1926	15408	1486	11888	23
Computer	8	150	1200	70	560	53
Projector	4	500	2000	200	800	60
Air Cooler	8	300	2400	170	1360	43
**Motor Pump (2hp)	1	1500	1500	1400	1400	7
*Refrigerator (190L)	24	43	1032	18	432	58

Note

* In case of refrigerators, nominal operating power has been considered based on annual energy consumption
 ** The energy efficient pump not only consumes less power but also gives higher flow rate (thus less time operation), therefore actual energy savings will be even more.

The solar team at the academic institution should make a plan to minimize the electricity use of about 1/3rd. This would require some investment. If not in one go, the replacement of the appliances can be done in a phased manner. The money saved from the step-1 should be used for achieving the target of step-2. Suppose the academic institution makes an investment in efficient appliances. In that case, it will help them to reduce the overall cost of the off-grid solar system, as the need for a generation will reduce significantly.

c. Step-3: Generate remaining 1/3rd

Once you have avoided what can be avoided (hopefully by 1/3rd) and minimized what can be minimized (hopefully by another 1/3rd), then remaining electricity (the 1/3rd) can be easily generated using the solar system without needing significant investment.

The 1/3rd-1/3rd-1/3rd approach is just a suggestion and depends on the institution's climatic situation, building design, the sensitivity of building users, etc. The percentage number of each step-1 to step-3 can vary. It is clear that the more you avoid step-1 and the more you minimize in step-2, the less you will generate in step-3.

Designing a solar system, finding out panel size and battery size for fulfilling the campus requirements, 24x7, 12 months in a year are discussed in the following sections.

8. Thumb rule for solar system design and costing

After applying Avoid and Minimize steps, the next step is to generate the remaining electricity needs using solar PV systems. In designing a solar PV system with battery back-up for given electricity needs, the following questions are to be answered:

- How much area is required?

- What would be the capacity of PV modules?
- How is much battery back-up required?
- How much would it cost?

Thumbs rules are given here to figure out the approximate answers to the above questions; however, please note that exact design and costing may vary by 10 to 20% depending on the needs and constraints of a given institution.

The design starts with a requirement of estimated electricity to be generated per day after applying Avoid and Minimize steps. Campus solar teams comprising students and faculty members will be trained to precisely estimate the daily energy requirements. It is assumed that if the campus's electricity consumption were monthly 10,000 units at the start of exercise, the electricity requirements would come down to only about 3500 units (best case) to 5000 units (good case) or 6000 units (average case) monthly after applying Avoid and Minimize steps.

Let's consider the best-case scenario of 3500 units requirement per month.

Area requirement: The rooftop area requirement in square feet is **one is to one** with monthly electricity unit requirements. It means that if you need to generate 3500 units per month using a solar PV system, you need 3500 square feet of area on the roof. If you need 4000 units per month, then you need 4000 square feet of area. Simple!



“Rooftop area requirement in square feet is one is to one with monthly electricity unit requirements”

PV module requirement: The PV module's capacity in Watt is **one is to 10** with the monthly units required. It means that if you need 3500 units of electricity per month, you will have to install 35000 Watt of PV

modules or 35 kW of PV modules. If you need to generate 4000 units per month, you need to install 40000 Watt or 40 kW of PV modules.



PV module's capacity in Watt is one is to 10 with the monthly units required

Battery requirement: the capacity of the battery required for academic campuses that run mainly during day time is one is to one with daily electricity requirements considering the use of lead-acid batteries. It means that if 3500 units are the campus's monthly requirement, daily requirements would be about 120 units. Therefore the battery needs to store 120 units of electricity. This is considering using lead-acid batteries (if we use Li-based batteries, we only need 60 units of storage). This battery back-up would ensure that the campus can run on full loads for 4 hours when sunshine is not there (which is assumed to be not the case for academic campuses running during the daytime). This battery back up would also take all night loads of street lights, security cameras, etc.



For academic campuses with daytime operations, battery storage requirement is one is to one with daily electricity requirements considering lead-acid

batteries

Cost estimation: the estimated cost of the entire solar system (in lakhs) with battery back-up for academic institutions is one is to 0.7 with solar power capacity in kW. When we need 3500 units per month, we need 35 kW of solar panels. Therefore, the entire system's cost, including everything, would be 0.7 of 35 in lakhs, that 0.7×35 or 24.5 or approximately 25 lakhs.



The cost of the entire solar system (in lakhs) with battery back-up for academic institutions is one is to 0.7 with solar power capacity in kW

In summary the thumb rule for designing the entire solar system for academic campuses running their operations in daytime can be written in the following way.

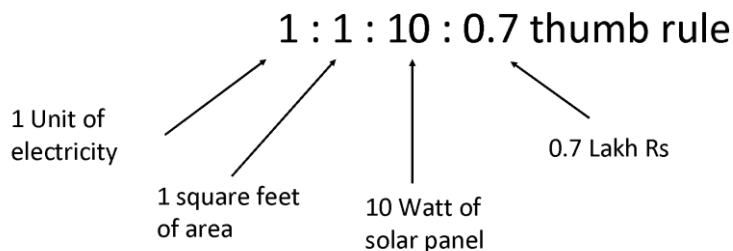

It is to be noted that this is just a thumb rule and depending on the requirements or at unusual geographical locations, the actual sizing and costing of PV systems would change. Everyone is advised to do complete calculations.

The above procedure is just a simple thumb rule based estimation. It is recommended that institutions perform detailed system design using the approach given in annexure-2

9. Step by step implementation towards 100% solar by locals for locals

It is proposed that the team from the institute only does the entire exercise of estimating the electricity needs of campus, applying avoid and minimize steps, designing solar system, installing solar systems, and even maintenance. **NO external consultant or installer is required in the entire exercise.** Appropriate training would be provided to the campus team to carry out this exercise on their own. This implementation

model will create ownership of the solution and confidence in the solar system and its operation. This would enable the repair and maintenance work for the system as and when required.



Step-1:

Team building – students and faculty

The first and most important step towards making any academic campus atmanirbhar is a dedicated and enthusiastic team. The core team need not be large. In any academic institution, one can always find dedicated faculty members and students, irrespective of the institution's location or nature. The core team can comprise the principal/director with 3 to 4 faculty members, and 3 to 4 students, 1 maintenance engineer (if any). Smaller the core team, the better it would be. Other sub-teams would be required to carry out the work. The core team should also prepare promotional material to educate the other campus users on what will happen, how the campus will become 100% solar-powered, and what is required from each one of them.



Step-2:

Energy Auditing

Once the team is identified, the next step would be to do the campus's energy audit. Finding out how much electricity (a) is used, (b) is wasted, (c) can be avoided, and (d) can be minimized. A systematic recording of the data would help make a good plan for converting any academic campus into a 100% solar-powered off-grid campus.

Promotional material on the campus to educate other users should also be planned.



Step-3:

Applying Avoid Formula

Involving the campus users using communication and interaction is an important aspect in achieving a 100% solar-powered campus. After

consultation with the campus residents, a plan should be made to avoid using appliances that can be avoided. A target should be kept for this activity, and the team should try to achieve the target in 2 to 3 months. The suggested target is a 1/3rd reduction in electricity consumption. The monthly electricity bill can be a good indication of the progress achieved. The core team should read the meter and monitor the progress.



Step-4:

Applying Avoid Formula

This step requires replacing old and inefficient appliances with new but efficient appliances. Earlier in the document, a table lists out the electricity-saving potential of efficient appliances. With appropriate and efficient appliances, a target to reduce electricity consumption by another 30% can be kept. The minimize operation can start from the beginning, and it can run in parallel to 'avoid' operation. The 'minimize' operation can run up to 6 months from the beginning. Money saved by reducing the electricity bill to avoid operation can be used to buy the efficient products and minimize operation. It would be best if the institute makes additional investment and complete the target of minimizing operation within 6 months.



Step-5:

Design and costing solar systems

Based on the thumb rule given in the design section, the core team can design a solar system to fulfil all campus requirements 24x7, 12 months a year. The beginning thumb rule can be used, but it is advised that the team does a detailed calculation to design the solar system and figure out the sizes of components like panels, batteries, electronics, wires, etc. Simultaneously, the cost estimation of each of the components can be done at this stage. This exercise can also run in parallel with the avoid and minimize operations.

It is strongly recommended that instead of designing one large system for the entire campus, small systems for different blocks or different wings or different zones or even different groups of rooms can be designed. Such a decentralized design would make it easy to procure, install, and maintain. It would be good and easy to install and maintain a small solar system for different sub-teams on the campus.



Step-6:

Procurement of solar system

Once the design is finalized, communication regarding the exercise is made with campus users, feedbacks are taken, and the procurement process can start. The best thing about solar PV systems is that they are designed and installed as small units (as small as independent light). Due to this reason, if funds are the issue, procurement can be done in small quantities, if required.



Step-7:

Installation of solar systems

A training program should be organized within the campus to teach campus users like faculty and students to learn about installing solar systems with hands-on experience. After getting such training, it is strongly recommended that all the installation of the solar system be done by the campus users only.



Step-8:

Documentation and Promotion

Everything that is designed and installed must be documented. This includes the design diagram of the system, writing all technical specifications of the system, writing the system's operational manual, writing the replacement manual of the components as and when required, putting the signages on the wires and various components of the system. The information about the solar system should also be displayed on the

campus. The display should continuously educate the campus users as well as newcomers.



Step-9:

Maintenance of solar systems

It is strongly recommended the use of the solar system is done as prescribed by the design and installation team. Also, the maintenance team should be well-identified in advance. Regular review of maintenance and status of the system should happen.

10. Timeline for implementation

Following two years' timeline is suggested to convert campuses into 100% solar powered campuses. The entire process will take upto two years to complete the entire 9 steps that have been listed in the section above. The timeline of the activities for the identification of the team and installation of the solar system is given in the table below:

Activity	Months																							
	1	2	3	4	5	6	7	8	9	10	11	12	13	14	15	16	17	18	19	20	21	22	23	24
Identify the team																								
Complete energy audit and find ways to 'Avoid'																								
Implement 'Minimize' plan																								
Completely solarization of the campus																								
Document, promote, create SoPs																								

Annexure-1 - Estimation of electricity needs within an academic institution

This annexure ONLY gives a tentative idea about the use of electricity in academic campuses. For actual estimation proper energy audit must be done.

Classroom loads: this includes fan and light loads in a classroom. A typical classroom is 400 to 600 square feet. A typical classroom would mainly consist of lights and fans.

Table-1 Energy Consumption of Classroom

Loads/ Rooms	For 1 Classroom, one light and one Fan per 100 Square feet	Total Power (Watt)	Daily Usage hours	Energy Consumption (Wh)
Fan (60 Watt)	4	240	8	1920
Light (40 Watt)	4	160	8	1280

Typically if the classroom is used for 8 hours in a day, about 3.2 kWh would be good enough for one-day operation if the normal loads are used. Here normal loads mean not energy efficient loads. These are the loads typically we are using in our daily lives. But now, there are advanced, more efficient loads that perform the same task but by consuming much less energy. A summary of efficient loads is given in the next section.

Additional loads may be there in the classroom like a projector and speaker.

Table-2 Energy Consumption of Additional loads in Classroom

Loads	one Projector in one class	Total Power (Watt)	Daily Usage hours	Energy Consumption (Wh)
Projector (500)	1	500	2	1000

Watt)				
Speaker with music system (50 Watt)	1	50	2	100

Total Energy Consumption for a day = 1.1 kW. Thus for a fully furnished classroom with a projector and sounds system, maximum energy consumption with normal load would be about 4 units.

Administrative loads: includes some common loads as follow:

Table-3 Energy Consumption of Administrative loads

Loads /Rooms	Princ ipal's Offic e	Offic e	Staf f Roo m	Libr ary	Corrid or	Total Quanti ty	Total power (Watt)	Daily Usage Hour	Energy Consumpt ion (Wh)
Light (1 light per 100 sq. feet) (40 Watt)	3	4	6	10	10	33	1320	6	7920
Fan (60 Watt)	2	4	4	5	5	20	1200	6	7200
Air Conditioner (2210 Watt)	1	1				2	4420	2	8840
Computers (in office) (250 Watt)	1	3	1	1		6	1500	6	9000
Printer (150 Watt)	1	3	1	1		6	900	1	900
Projector (500 Watt)	1	1		1		3	1500	2	3000

Total Energy Consumption per Day = 36860 Wh = 36.86kWh

Table-4 Energy Consumption of Additional Administrative loads

Loads/Rooms	Total Power (Watt)	Daily Usage Hour	Energy Consumption (Wh)
Water Cooler	80	8	640
Water Pump	500	1	500
Security Camera and Monitoring System	10	24	240
In Pantry			
Exhaust Fan	6	2	12
Induction Stove	2000	1	2000
Microwave Oven	600	1	600
Exhaust fan In toilets	10	2	20

Total Energy Consumption per day for the additional loads = 4012Wh = 4.012kWh

3) Laboratory loads - This type of loads are of high ratings which vary as per the requirement of the institutes. Generally, Engineering colleges and Industrial Training Institutes (ITI) have welding, foundry and smiting workshops, electrical, mechanical and electronics lab where experiments are done at high voltages also, physics and chemistry labs. This lab requires high rated machines which includes motors, inverters, rectifiers and transformers.

Table-5 Energy Consumption of loads in laboratory

Loads/Room	Biolo gy Lab	Comp uter Lab	Chemi stry Lab	Dra w ing Room	Ph y. lab	Total Quant ity	Tota l power (Watt)	Dail y Usa ge Hour	Energy Consum ption (Wh)
Light (1	4	4	4	4	4	20	800	4	3200

light per 100 sq. feet) (40 Watt)									
Fan (60 Watt)	4	4	4	4	4	20	1200	4	4800
Computers (250 Watt)	1	20	1		1	23	5750	4	23000

Total Energy Consumption in a day = 31000Wh = 31kWh

Table-6 Energy Consumption of Additional loads in Laboratory

Loads/Rooms	Computer Lab	Total power (Watt)	Daily Usage Hour	Energy Consumption (Wh)
Air conditioner (2210 Watt)	5	11050	2	22100
Projector (500 Watt)	1	500	2	1000

Total Energy Consumption for the additional load in a day = 22.2kWh

Annexure-2: Approach for designing solar off-grid systems

Design of Off-grid Solar PV Systems

Off-grid solar PV module systems are standalone, independent solar systems. They are not connected with the electricity grid and therefore have their own energy storage in batteries for non-sunshine hours. In current context, such systems are suitable for both urban and rural areas. If a household or institution goes off the grid, it reduces burden on electricity grid, cost and maintenance of electricity grids and avoids transmission and distribution losses. Solar PV modules as well as batteries have improved greatly in terms of performance. PV modules with good efficiencies are easily available commercially. But more importantly cost of PV modules on per Watt basis and cost of batteries on per kWh basis have been reducing. As a result, the localized generation and consumption of electricity, in the form of solar off-grid system is becoming increasingly economically viable electricity option for both urban as well as rural households, academic as well as commercial institutions.

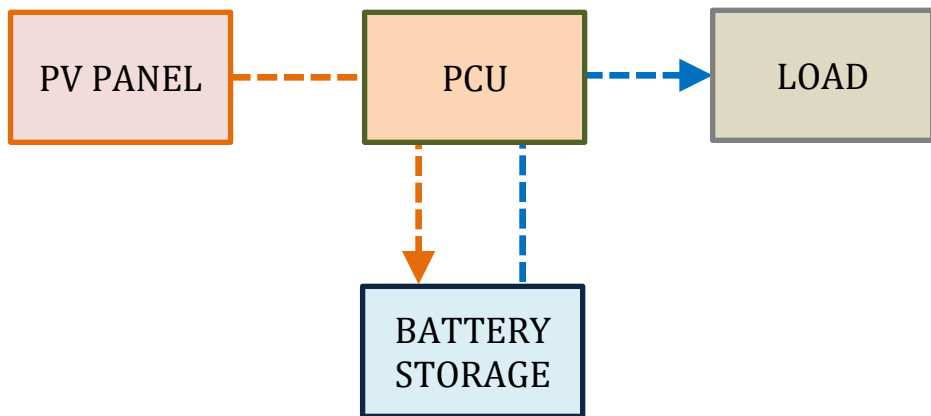

Fig. 1: Block diagram of a standalone off-grid solar PV system.

This section helps you to design an off-grid solar PV system to fulfill load energy demand in all possible weather conditions for a given load. After going through this section one should learn the following things:

- How to estimate the load (energy and power) requirements
- Determine whether to design a DC solar system, AC solar system or hybrid off-grid solar system
- Determine the capacity of DC controller or AC inverter
- Sizing the battery requirement for the system
- Sizing PV module requirements for the system
- **Sizing of the wire requirements for the system**

Types of off-grid solar PV systems

- DC solar systems

It is simplest type of off-grid solar PV system, mainly comprising of the PV modules and DC loads. Battery energy storage can be also included as per the user requirements to operate it during the off sun shine hours. Since solar PV panel generates the DC power and the connected loads are also the DC loads, it does not require the inverters. However, for maximum utilization of solar power generation and to protect the batteries from over and under charge conditions, electronic controllers are used in between to regulate the power supply between different components of the PV system.

DC solar systems can be as simple as a solar DC fan, in which a DC fan is directly connected with the solar PV module of appropriate ratings. Or it can be a DC PV system with battery storage and solar charge controller (SCC) powering various DC appliances such as lights, fan, TV, computers, etc.

- AC solar systems

This is the most common configuration of off-grid solar PV system, where the connected loads are AC (alternating current) based and therefore it essentially needs inverter to power the AC appliances. All other requirements of the system components such as PV modules, batteries, solar charge controller (SCC), maximum power point tracker (MPPT) etc. remain the same as in case of DC solar systems. Now a days, the

features of MPPT and SCC come with the inverters itself, and it is called solar inverter or solar power conditioning unit (PCU).

- Hybrid solar systems

The hybrid solar PV systems incorporate both types of loads (AC and DC). In the hybrid systems, system configuration at the supply side is slightly intricate than the previous types. The supply to DC and AC loads are separately managed but from the same source. The AC loads are connected through an inverter of appropriate ratings and DC loads are connected through solar charge controller.

Step by step design of solar PV system

Step-1: Identify the daily load requirements (total Watt and Watt-hour)

This is the first and foremost step of the PV system design. The procedure is given under the following steps:

- i) Identify various types of loads (AC or DC) and their numbers already connected or to be connected in a PV system. (Note: It is more likely that all the loads used in an institutions are AC loads. Also it is likely that though the load like LED bulbs work on DC, but are powered by AC with small electronics inside the bulb that converts AC into DC).
- ii) Identify power ratings (wattage) of the individual loads/appliances.
- iii) Multiply power ratings (W) of a particular appliance with number of appliance.
- iv) Sum up all different loads to find **total load requirements** for the PV system design.
- v) Also find number of hours of average daily operation of individual loads.

- vi) Multiply number of hours (h) of daily operation with the power ratings (W) of corresponding loads. This gives the daily energy requirement (Wh) for the particular load/appliance.
- vii) Sum up daily energy requirements of all different loads. This gives the **total daily energy requirements** (Wh) for the PV system design.

Alternatively, the connected load and monthly electricity requirements can be obtained from the electricity bills, if the user wants to switch completely on solar PV with the existing loads. The electricity bills also provide the electricity consumption pattern throughout the year, thus better estimation of electricity requirements for the system design.

Note that 1 unit of electricity is equal to 1000 Wh or 1 kWh. Our monthly electricity bill comes in units or kWh.

Lets take an example: The electrical load information provided by a household in Mumbai sub-urban region is given in table 1. Also, the monthly electricity bills are provided for the past 12 months as given in table 2. User wants to surrender the existing electricity connection and go for solar off-grid solution. Design an off-grid solar PV system to fulfill load energy demand in all possible weather conditions for the use

Table 1: power ratings, quantity, and average daily usage of various connected loads (AC)

Appliances	Power rating (W)	Quantity	Total power (W)	Daily avg. usage (h)	Total energy consumed (=W x h)
Tube light	20	2	40	5	200
LED bulb	10	6	60	10	600
Table fan	30	2	60	4	240
Ceiling fan	75	4	300	10	3000

22" LED television	20	1	20	10	200
Mobile Charging	10	3	30	2	60
Desktop computer	100	1	100	8	800
Mixer-grinder	700	1	700	0.2	140
Microwave- oven	1000	1	1000	0.1	100
190 Lt. refrigerator	100	1	100	24	2400
Air conditioner	2000	1	2000	4	8000
0.5 HP water pump	380	1	380	0.5	190
Total connected Load ->			4790	Energy ->	15930

In order to convert above electricity needs in Wh to kWh we need to divide it by 1000. Here $15930/1000$ per day = 15.93 kWh / day. In order to convert above in monthly electricity bill, we need to multiply with 30 day of month, so it becomes $15.93 \times 30 = 477.9$ units /month or 477.9 kWh/month. Just for an example, the typical monthly electricity bills of the user for the past 12 months is given in the table below. Typically one should design a solar system considering the worst month or highest month's requirement.

Month	Electricity Units (kWh)
JAN	483
FEB	532
MAR	646
APR	772
MAY	810
JUN	764
JULY	526
AUG	496
SEPT	431
OCT	562
NOV	438
DEC	453

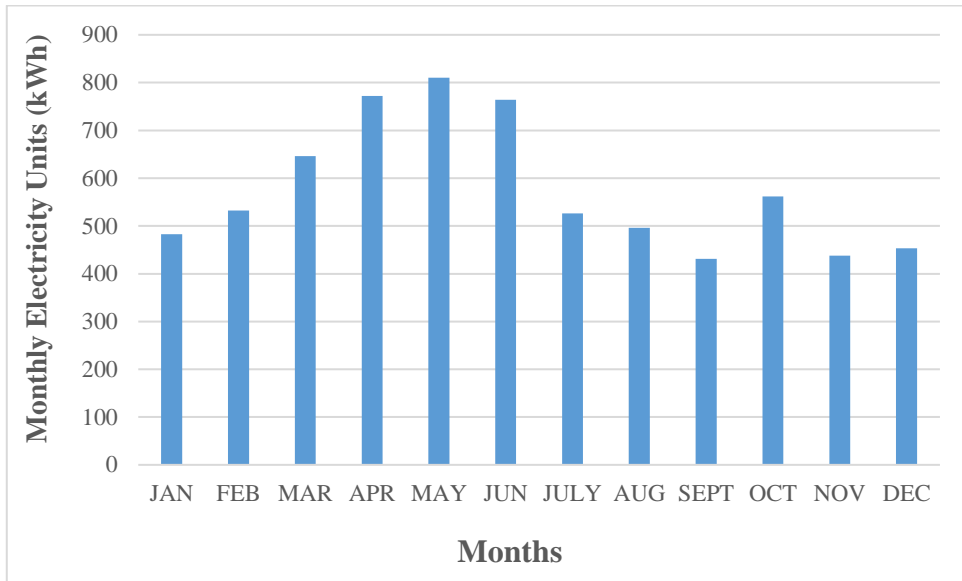

Fig. 2: Bar-chart showing the electricity consumption pattern of a user.

The higher electricity consumption observed in the October, and summer months is supposed to be mainly due to the higher cooling loads.

Step-2: Deciding DC or AC or Hybrid solar system

In the PV system design, the next step is to make a decision whether it is a DC, AC or a hybrid PV system. As per the information obtained in the previous step with respect to electricity consumption and various connected loads, we identify the suitable configuration of the PV system.

In general, DC solar PV systems are more energy efficient because power inversion is not required as in case of AC solar systems, thus it saves energy. At present, energy efficient DC appliances are also available in the market such as LED lights, fan, TV, refrigerator etc. Thus, DC solar system is preferred if there is no significant addition of the cost for replacement of appliances and wiring. However, replacement cost is also a major factor and we go for the AC solar system, trying to utilize the available electrical infrastructure (appliances, inverter, batteries, wiring etc.).

As a thumb rule, DC solar systems are preferred for the households with the smaller and basic electricity needs such as lights, fan, mobile charging, television etc. AC solar systems are preferred in case of higher electricity needs like air conditioning, washing machine etc. However, still there is a scope of improvement in the systems efficiency by the hybrid approach. In which, some of the appliances of major electricity consumption can be shifted to the DC power and some appliances can run on AC power.

Thus, for the given example (table-1 & 2), we proceed with the AC solar system design, the most common form of the off-grid solar system.

Step-3: Determine the ratings of power controller

In case of small DC solar systems, the power controller can simply be a solar charge controller (SCC) or the SCC with inbuilt maximum power point tracker (MPPT). For AC or hybrid solar PV systems, it is a solar inverter or a solar PCU incorporating the features of SCC, MPPT, and inverter.

The rating of SCC is identified based on design parameters such as system voltage (or the terminal voltage of the battery storage), maximum solar charging current, maximum solar input voltage, and maximum connected load (W).

Maximum load (VA) and the system voltage (or the terminal voltage of battery storage) are the two basic parameters to determine the ratings of the solar PCU. Maximum PV input power (power at MPP), solar input DC voltage (Voc), and maximum DC charging current (Isc) are some other key parameters for the input side.

For the given example, the rating of solar PCU can be identified as follows:

- i) VA (volt-ampere) rating of the PCU = total watt rating of the connected AC loads/ power factor = $4790 \text{ W} / 0.85 = \mathbf{5635 \text{ VA}}$.

Since, power factor is not available for the individual loads. It is assumed to be 0.85 for all loads.

Therefore, we need to choose the off grid solar PCU whose VA rating is higher than this calculated value. Solar PCUs come with standard models of specific VA ratings such as 2000VA, 3750VA, 5000VA, 7500VA, 10000VA, etc. So we need to select the correct model of the PCU.

In general, the PV array of similar power rating (peak power) can be connected with the system however it is manufacturer specific.

- ii) System voltage or terminal voltage of the battery bank = **96 V**. It can be 24V, 48V, 60V, 108V or any other voltage number of multiple of 12V. Typically for higher power system, higher voltage is chosen so that the current flow is reduced.

These (point i and point ii) are the two main ratings of the solar PCU.

- iii) Maximum DC charging current depends on current rating of the SCC of the PCU. Solar PCU comes with different models with different ampere ratings of SCC like 20A, 50A, 70A etc. So, one can select the suitable PCU model.

Maximum DC charging current and solar input DC voltage can be tuned as per allowed range of solar PCU, with appropriate configuration (series/parallel) of PV modules.

Step-4: Determine battery capacity and its configuration

For the off sun shine hours supply of electricity we need a battery storage. The capacity of this battery storage is determined from the total energy requirement during off sun shine hours. However, we need to consider various energy losses that take place during charge storage, inversion and transmission. Depth of discharge (DoD)

and the autonomy period are the two additional parameters that must be taken into account while determining the battery capacity.

The DoD is referred to a recommended level of battery discharge giving standard span of battery life. Generally the lead acid batteries are used in solar PV systems, with recommended DoD of 50-60%. Thus if considering 50% DoD, only half of the battery capacity can be utilized.

The autonomy period is another important parameter in determining the required battery capacity. Since, the battery can only supply the energy which is been stored during the sun shine hours. For the system operation in the cloudy days or rainy season, accordingly we need to store more energy into the batteries. This enhances the reliability of the PV system, however increases the cost of the system. Thus, if we want to run the system for an extra day considering cloudy condition, the battery capacity needs to be of doubled (2 days of autonomy).

It is found that even under the cloudy or the rainy condition, there is at least 1/3rd of the total generation still takes place. Generally, PV systems are designed with an autonomy period of one day. However, as per the user's choice, maximum two days of autonomy period is recommended for the off grid solar PV system.

The battery configuration depends on the system voltage or terminal voltage of the battery storage. For example, in a 12V system, the 12V batteries are connected in parallel to match the required capacity. For a 48V system, four batteries of 12V and appropriate capacity (Ah) are connected in series to match the requirements.

Generally, DC solar systems with smaller battery capacities are designed at 12/24 V, whereas large AC solar systems are designed at 48/96V of the battery terminal voltage.

For the given example,

- i) Find the user's **maximum daily electricity need**.

The user's electricity bills (table-2) show that the highest electricity demand is in the May month = 810 kWh. So, daily electricity need = $810 \text{ kWh} / 31 \text{ days} \approx \mathbf{26 \text{ kWh}}$.

- ii) Find % of total electricity needs that is to be used during off sun shine hours. It is user specific. Let us assume that 50% of the total daily electricity consumption is during the off sun shine hours.

Thus, the maximum daily electricity need during off sun shine hours = **13 kWh** (this can be chosen by the use, depending on the duration of night time operation, for academic institution, night time operation can only be 10-20% of total electricity consumption)

- iii) Determine actual energy storage (kWh), considering various energy losses.

In general, ~10% energy is lost in the charge-discharge cycle, thus efficiency = 0.9. Furthermore, ~15% of the energy is lost during DC-AC inversion, so inverter efficiency = 0.85, which is manufacturer specific and also depend on load level.

Thus total energy (kWh) that needs to be stored = $13 \text{ kWh} / (0.9 \times 0.85) = \mathbf{17 \text{ kWh}}$

- iv) Find actual energy storage considering the recommended DoD of 50%.

So, the required energy storage for the PV system = $17 \text{ kWh} / 0.5 = \mathbf{34 \text{ kWh}}$

- v) Mostly the autonomy period is considered to be 1 day only. However, as per the user's choice to enhance the system reliability during the monsoon season, at max it is increased to 2 days.

Considering 2 days of autonomy (this depends on the reliability of solar system required, if the loads are not critical than 1 day of autonomy should be sufficient), the required energy storage = $34 \text{ kWh} \times 2 = \mathbf{68 \text{ kWh}}$

- vi) Determine the battery capacity (Ah) and its configuration to store this energy.

Considering single day autonomy period (as two day autonomy will be more reliable but more expensive), the energy storage = 34 kWh
= 34000 Wh

Suppose, this is a 96V system. So, the battery capacity = 34000 Wh / 96V

= **354 Ah** battery of **96V = 354 Ah series-connected 8 batteries of 12V**

Since, 354 Ah batteries are not available in the market. So, we can have two sets (series connected 8 batteries of 12V) of 177 Ah (half of 354Ah) capacity and connect them in parallel.

Therefore, 16 batteries (12V and at least 177 Ah capacity) are needed of which 8 are connected in series and two such sets are connected in parallel.

Step-5: Take solar radiation of the site in account

Since, the PV electricity generation depends on solar radiation incident on solar panel, which is not same all over the world or at all time. It depends on location, time, and climatic conditions of the site. Thus, solar radiation data has to be taken into account for more accurate prediction of PV generation and thus enhanced reliability of the PV system. Total electricity generation per kWp of the PV installation can be estimated from solar radiation data of the site. This helps in identifying required PV module capacity sufficient to exactly meet the electricity requirements all the time.

For the given example, the average global solar radiation (kWh / m² –day) data for the installation site (Mumbai) is obtained as given below in table 3.

Table 3: Global solar radiation (kWh / m² –day) data _Mumbai

(Ref. <https://maps.nrel.gov/rede-india/>)

Month	Global solar radiation (kWh / m ² –day)
JAN	5.08
FEB	5.91
MAR	6.63
APR	7.00
MAY	6.98
JUN	5.27
JULY	4.36
AUG	4.46
SEPT	5.09
OCT	5.41
NOV	5.00
DEC	4.73

The daily solar radiation is given in terms of kWh /m² –day, varying from 4 to 7 kWh /m² –day. This is a significant variation and needs to be considered in the system design.

Step-6: Determine solar PV module capacity and its configuration

PV module capacity of the system required to fulfill load / energy demand in all possible weather conditions is determined from monthly electricity consumption pattern and the monthly electricity generation per kWp PV installation. However, various energy losses that take place during the generation, storage, and consumption (inversion and transmission) needs to be accounted.

The PV module configuration is selected based on the ratings of the available PV modules and the SCC or the solar PCU.

For the given example,

To determine the PV module capacity and its configuration, we need to follow the following steps:

- i) Find out the global solar radiation of the site (as given in table -3)

- ii) Determine electricity generation from the per kWp installation of solar PV modules

Let us calculate it for the January month,

For this month, daily solar radiation = 5 kWh/m^2 –day.

Since, the PV modules are rated for the incident solar radiation of 1000 W/m^2 (one of the standard test conditions or STC).

Therefore, the daily solar radiation of 5 kWh/m^2 –day can be written as,

$$5 \text{ kWh/m}^2 \text{ –day} = 1 \text{ kW/m}^2 \times 5 \text{ h/day}$$

(**STC radiation**) x (**equivalent daily sun shine hours**)

PV module of 1 kWp power rating will receive STC solar radiation for 5 hours, thus it will generate $1 \text{ kW} \times 5 \text{ hours} = 5 \text{ kWh}$ of PV electricity under ideal condition (STC and MPP operation).

- iii) Determine the actual PV electricity generation considering various losses

Basically, there are 3 main energy losses that take place during the PV electricity generation:

a) Temperature loss

PV module gives rated output at the rated operating temperature of $25 \text{ }^\circ\text{C}$ (STC). However, the field operating temperatures can be as high as $68 \text{ }^\circ\text{C}$ in the summer depending on site. Thus, actual power generation from the PV module is reduced depending on module operating temperatures. The % reduction in the PV module's power output per $^\circ\text{C}$ increase in the module operating temperature is known as **temperature coefficient of power**. For the most widely used c-Si PV modules, the value of temperature coefficient of power is $-0.5 \text{ \%}/^\circ\text{C}$.

Thus, for the given example considering avg. module operating temperature of 55 °C in the summer, the power loss = $(55\text{ °C} - 25\text{ °C}) \times 0.5\% / \text{°C} = 15\%$.

Therefore, loss factor due to Non-STC temperature operation is **0.85**

b) Charge controller efficiency loss

Since the extracted power from the PV module also depend on operating power point on the I-V characteristics of the PV module. PWM (pulse width modulation) and MPPT (maximum power point tracking) based charge controllers are used in PV systems. PWM based charge controllers are cheaper but have the lower efficiency of ~75-80% and they are preferred for smaller DC solar systems. The MPPT based charge controllers are costly but very efficient (~98%) and preferred to use in large AC solar systems.

Therefore, we use MPPT based charge controller having power loss of only **2%**

c) Other losses due to dust accumulation on module surface and slight variation in the correct PV installation

This is another important loss in the PV generation. However, it is recommended to regularly clean the PV modules (at least once in a week) and follow the standard installation procedures. Sometimes, due to non-availability of ideal tilt or orientation of the roof-tops, we lose some power.

For this example, let us assume **5%** loss in power. Therefore, loss factor due to this loss in power is **0.95**.

Thus, let us find the **actual PV generation per kWp installation**, considering these losses. For this, we multiply the

ideal PV generation with the various **efficiencies** or **loss factors** involved.

$$\text{Actual generation} = \text{ideal generation} \times 0.85 \times 0.98 \times 0.95 = 5 \text{ kWh} \times 0.79 = \mathbf{3.96 \text{ kWh}}$$

- iv) Determine **electricity (available to load)** from per kWp PV installation

Since, the same generated PV electricity is not available to the loads. It undergoes various other losses in the storage and inversion and transmission. Therefore, the PV module capacity must be determined considering these energy losses.

For the given example,

Considering 10% loss in battery storage, 15% loss in power inversion, and 2% loss in the transmission (mainly in the DC side).

Available electricity per kWp PV installation = actual generation x loss factors

$$= \mathbf{3.96 \text{ kWh}} \times 0.90 \times 0.85 \times 0.98 = \mathbf{2.97 \text{ kWh}}$$

- v) Similarly, obtain the electricity generation (available to load) for all months, as given in table 4.

Table 4: Electricity generation from per kWp PV installation _Mumbai

Month	Global solar radiation (kWh / m ² –day)	Generation under STC (kWh)	Actual electricity generation (kWh)	Electricity available to load (kWh)	Electricity available to load (kWh/ month)
JAN	5.08	5.08	4.02	3.01	93

FEB	5.91	5.91	4.68	3.51	102
MAR	6.63	6.63	5.25	3.93	122
APR	7.00	7.00	5.54	4.15	125
MAY	6.98	6.98	5.52	4.14	128
JUN	5.27	5.27	4.17	3.13	94
JULY	4.36	4.36	3.45	2.59	80
AUG	4.46	4.46	3.53	2.65	82
SEPT	5.09	5.09	4.03	3.02	91
OCT	5.41	5.41	4.28	3.21	99
NOV	5.00	5.00	3.96	2.97	89
DEC	4.73	4.73	3.74	2.81	87

- vi) Find the required total PV capacity to meet the electricity demand all weather conditions

PV capacity required = Max. Consumption / Min. Generation (per kWp PV installation)

$$= 810 / 80 \approx 10 \text{ kWp}$$

However, this is a very conservative approach to find out the PV module capacity for the system.

However, it can be more accurately predicted if we plot both the generation and consumption data side by side. In the summer months, the consumption is observed to be higher. But at the same time generation is also higher due to higher incident solar radiation.

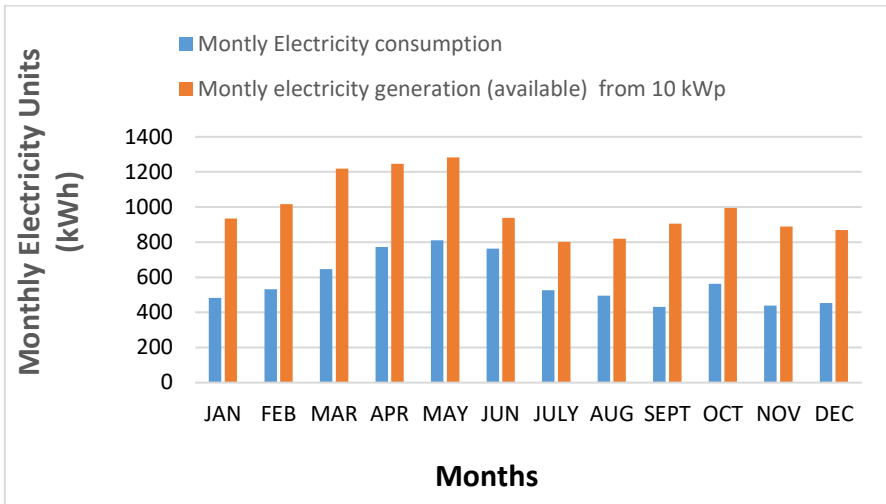

Fig. 3: Bar-chart showing monthly electricity cons. /gen. pattern for 10 kWp PV system.

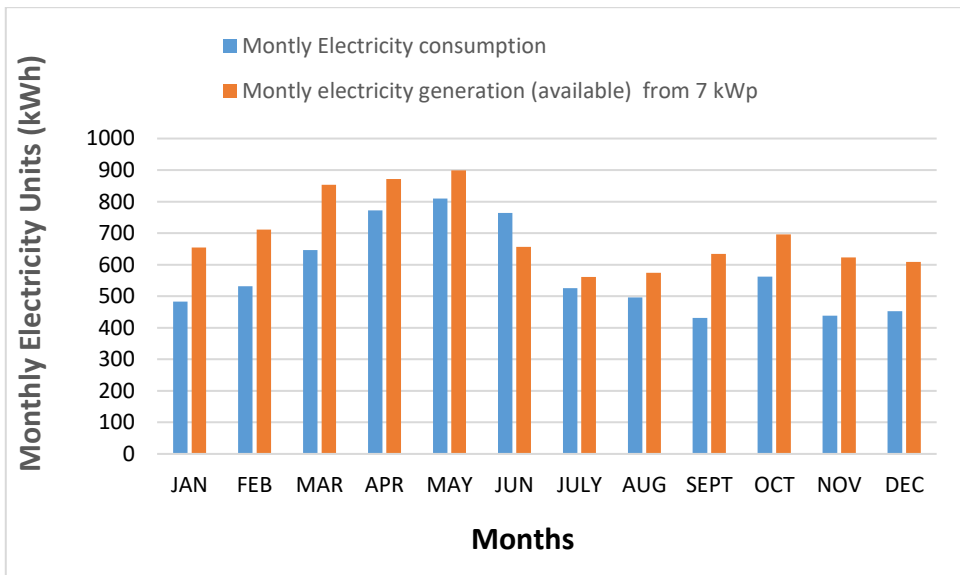

Fig. 4: Bar-chart showing monthly electricity cons. /gen. pattern for 7 kWp PV system.

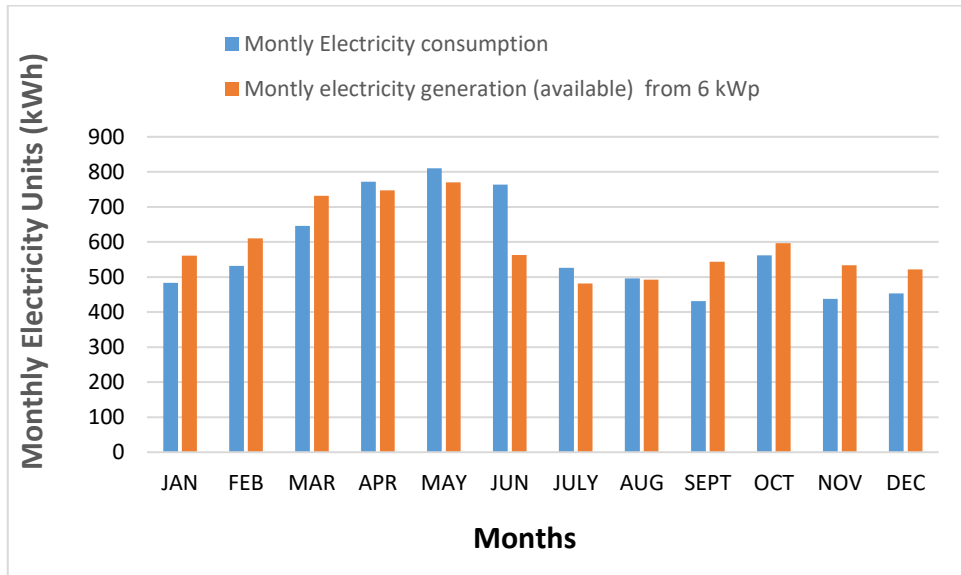

Fig. 5: Bar-chart showing monthly electricity cons. /gen. pattern for 6 kWp PV system.

Thus, for the given example, 7 kWp PV module capacity will be sufficient to meet the electricity demand of the user.

The configuration of PV modules in an array of PV system is determined based on the module ratings and the recommended range of input parameters of the solar PCU.

The PV modules come with different power (Wp) ratings such as 250Wp, 260Wp, 300Wp, 325Wp, 350Wp, etc. The Voltage (Voc) rating of the modules depends on the number of solar cells connected in series. In general, either 60 or 72 solar cells configuration is used (Voc ~ 36V or 43V). The Current (Isc) rating of the modules depend on the individual solar cell size (area). Currently, the 6 inch (15.6 x 15.6 cm²) solar cells are used and the cell/ module current (Isc) is of ~9-10A. It is always preferred to use higher Wp PV modules because their cost (Rs/Wp) comparatively low. Therefore, one has to select the appropriate model to form PV array of the given power capacity and within the voltage/current range compatible to the solar PCU.

For the given example,

No. of modules = required PV module capacity (W_p) / power (W_p) rating of individual module

= $7 \text{ kW}_p / 350 \text{ W}_p$ (suppose, we use 350 W_p of $V_{oc} \sim 43V$ modules)

$$= 7000 \text{ W}_p / 350 \text{ W}_p$$

$$= 20 \text{ modules of } 350 \text{ W}_p$$

For the series/parallel configuration of PV modules in the PV array:

For 20 PV modules, 5x4 or 4x5 configuration can be used depending on ratings of the available solar PCU.

In case of 5x4 configuration (**5 modules in series** and 4 such series connected in parallel)

The open circuit voltage (V_{oc}) of the PV array = $5 \times 43V = 215V$

The short circuit current (I_{sc}) of the PV array = $4 \times 10A = 40 \text{ A}$

In case of 4x5 configuration (**4 modules in series** and 5 such series connected in parallel)

The open circuit voltage (V_{oc}) of the PV array = $4 \times 43V = 172 \text{ V}$

The short circuit current (I_{sc}) of the PV array = $5 \times 10A = 50 \text{ A}$

Thus, either configuration can be used depending on PCU's DC input voltage range. However, it is preferred to use 5x4 configuration because the current is lower thus lower energy loss, if using wire of same SWG. Also, if the 4x5 configuration is used, then it is suggested to use the PCU model with higher CC rating (i.e. 70A).

Step-7: Determine the wire sizing between different system components and its ratings

Wire sizing (determine wire thickness) is an important aspect of the PV system design because it may introduce significant energy loss (in terms of voltage drop) and unreliability, if not selecting the wires of appropriate ratings between different components of the PV system. It is always desired to keep minimum possible distance between the two system components, particularly in the generation side. Because it introduces significant energy loss and cost to the PV system. For details, please read Chapter 9 of the book ‘Solar Photovoltaic Technology and Systems: A Manual for Technicians, Trainers and Engineers, Chetan Singh Solanki, PHI, 2013’. Following steps are given for the wire sizing calculation:

- i) Find the one way length between the two system components
- ii) Select the type of material/metal of the wire. Generally, Cu wires are used in the PV systems.
- iii) Use the appropriate method to calculate the wire size (diameter) for the allowed voltage drop (Not >2%, recommended)
- iv) Decide any other specific requirements of the wire/cable. For example: UV resistant encapsulation is recommended for the outdoors wirings (generally the PV module to the solar PCU).

For the given example,

Let’s do the wire sizing for the input side (between PV module and solar PCU)

- v) Suppose the one way length between PV array and solar PCU, along favorable path of wiring is 60 feet (including 10 feet extra length for keeping the safe margin for regular maintenance work)
In this example, we will use the 3rd method of wire sizing known as voltage drop index (VDI) method.

$$VDI = \frac{\text{Ampere} \times \text{Feet}}{\% \text{ Voltage Drop} \times \text{Voltage}}$$

Where,

Ampere is the maximum current (A) through circuit. For this case it is the I_{sc} of the PV array.

Feet is one-way wire distance between the two system components

% voltage drop is the desired percentage of voltage drop. Assume 2% (recommended)

Voltage is the nominal system voltage. For this case it is the voltage at the maximum power point (V_{mp}) of PV array, **NOT the V_{oc}** , because the system operates most of time near the V_{oc} . V_{mp} is roughly about 80% of V_{oc} .

Thus assuming the 5x4 configuration of PV array, i.e. $V_{mp} \sim 172V$, $I_{sc} \sim 40A$

$$VDI = \frac{40 \times 60}{2 \times 172} = \mathbf{6.98}$$

Using the VDI chart for copper wire:

VDI	Wire Size (SWG)
8	9
6	10

Therefore, wire size required is of **SWG#9** (cross-section of **~10 sq. mm.** or thickness ~3.5 mm) and the length is 60 feet (dual core cable) or 120 feet (single core). It is a Cu wire with UV-resistant encapsulation. See the tables for standard wire gauge (SWG) dimensions and VDI chart in the chapter-9 of the reference book.

For, AC (load) side, usual standard wiring is used. However, wires of appropriate wire thickness (SWG) must be used between the Battery storage and the PCU, and to make the series parallel battery connections,

Thus, ratings and configuration of PV system in the given example is summarized in the following table:

Table 5: rating of the different components of the AC solar system designed for the example

PV Array	Battery	Solar PCU	Wire
7 kWp 20 modules 350 Wp (5x4 configuration) Voc~ 215V Isc ~ 40A (under STC)	34 kWh 16 batteries (12V) of ~177 Ah capacity (8x2 configuration) (considering 1 day autonomy)	7500VA, 96 V Solar Input ~7 kWp 50A of CC rating Solar input voltage range (140-240V DC)	10 sq. mm. (SWG#9) 60 feet (dual core) Or 120 feet (single core) Insulation: UV-resistant (for generation side: bw PV array and PCU)

Suggested Calculations:

1. Design a DC solar PV system to operate one table fan of 20 watts directly running on solar PV module, without any battery storage.

.....

2. Design a DC solar PV system for a home to operate 3 DC fans of 30 watts each running for 6 hours a day, 3 LED lights of 10 watts each running for 8 hours a day and a mobile charging unit of 10 watts running 3 hours a day (considering battery autonomy of 1 day)

.....

3. Considering the same example with the load profile given in this chapter. If the user wants to replace all the ceiling fans (AC) with the efficient 30 watts DC fan. Then, design the hybrid solar PV system for the same.

Important Notes:

1. Always prefer to use MPPT based inverters or the solar PCU.
2. Module operating temperature is different than the ambient temperature. It is always higher than the ambient temperatures. Since, only a small portion of the sunlight is taking part in the electricity generation and rest of it is wasted as heat, which is not so readily dissipated from the module surface thus increasing the module temperature.
3. The loss or efficiency factors used in the calculations of the PV electricity generation or the energy loss, are multiplied not added. This is because the losses are happening one after another and not simultaneously.
4. Always a safe margin has to be considered to determine the power ratings of the solar inverter or the PCU. Because, the current and voltage ratings of the modules are given based on STC (1000 W/m^2) of the solar radiation. In actual practice, sometimes the solar radiation goes beyond this value (i.e. $1100, 1200, \text{W/m}^2$) due to higher incident solar radiation or sudden reflections from the clouds.
5. It is preferred to use higher voltage configuration of the PV modules (following electrical safety protocols) rather higher current configuration. Because, using higher current configuration leads to requirements of thicker wires and higher ampere rating SCCs.
6. Wire thickness refers to the thickness without insulation.
7. Wires of appropriate thickness (SWG) and color coding must be used to make the connections between the PCU and battery storage, and the batteries inter-connections.

8. Installer must keep a safe margin for the wire length (i.e. 5-10 feet extra length between PV array and the PCU) for the regular system maintenance works.

References:

[1] Solar Photovoltaic Technology and Systems: A Manual for Technicians, Trainers and Engineers, Chetan Singh Solanki, PHI, 2013

[2] <https://maps.nrel.gov/rede-india/>

